

SENTRY

LED FLOODLIGHT

1200W



Brightman™
design efficiency



TECHNICAL DATA

SENTRY FLOODLIGHT 1200W

Input Voltage	AC90-305V ~ 50/60 Hz
LED Chips	Philips Lumileds
Driver	Meanwell
LED Power	1200W
Led Luminous Efficiency	165lm/W
Luminous Flux	198,000lm
Power Factor	>0.95
Colour Temperature	2700K-6500K
Colour Rendering Index	Ra≥70
Bean Angle	10°, 30°, 60°, 90°, 120°
Illuminance Design	LED+lens
Working Temperature	-40°C ~ 60°C
Working Humidity	15%~ 90% RH
IP Rating	IP66
Net weight	24.2Kg
Life-span	>50,000hrs
Power Cable	1.0mm ² Triple shield wire
Connection Wire	Brown=Live, Blue=Neutral, Yellow=Earth
Housing Material	Die Cast Aluminum, A4 Stainless Steel
Housing Colour	Black
Mounting Options	Pole or Surface
Optional Extras	Daylight Sensor, Dali Dimmer



DIMENSIONS

SENTRY FLOODLIGHT 1200W

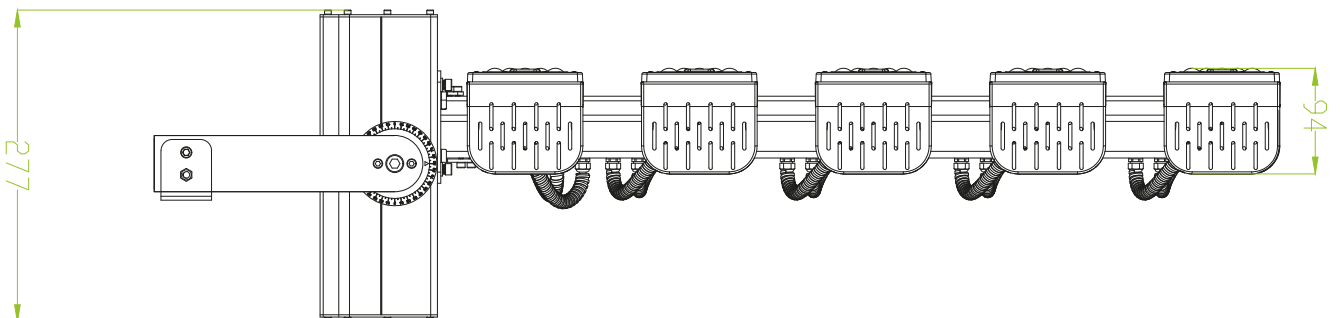
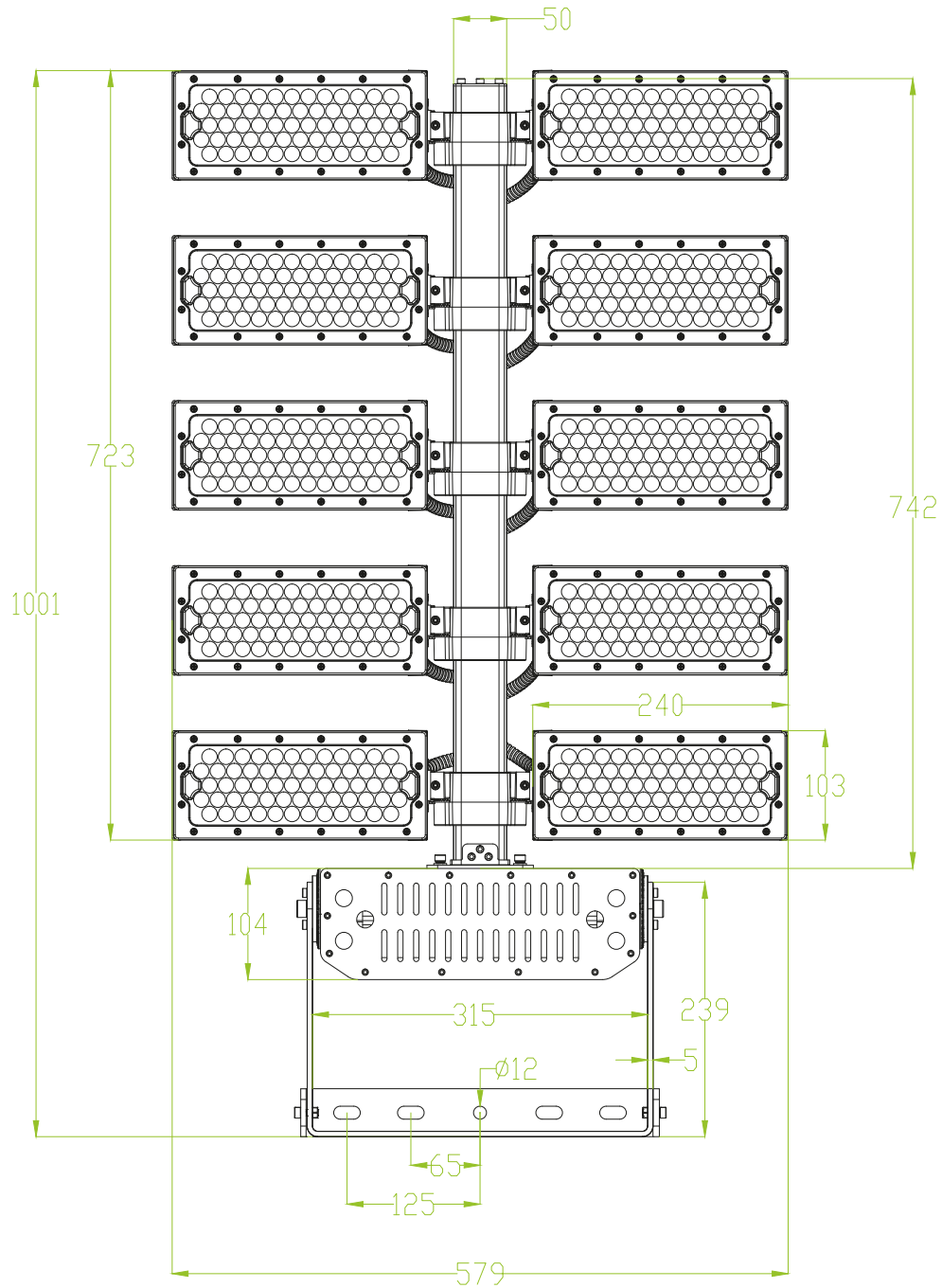

PHOTOMETRICS

SENTRY FLOODLIGHT 1200W

10° Lens

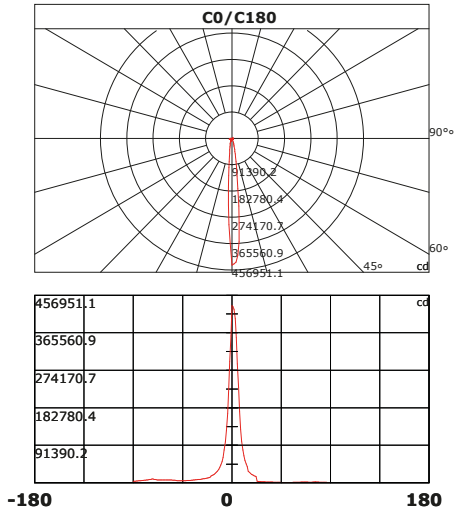

30° Lens

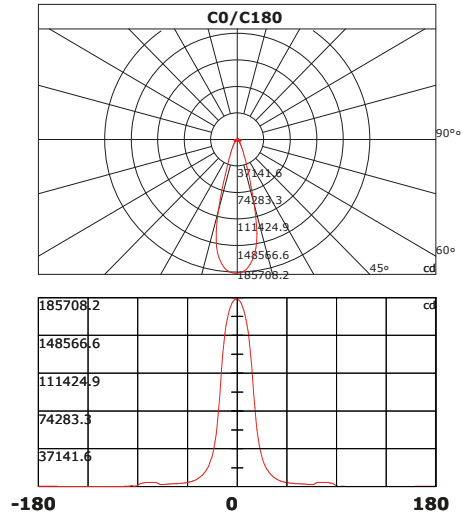

60° Lens

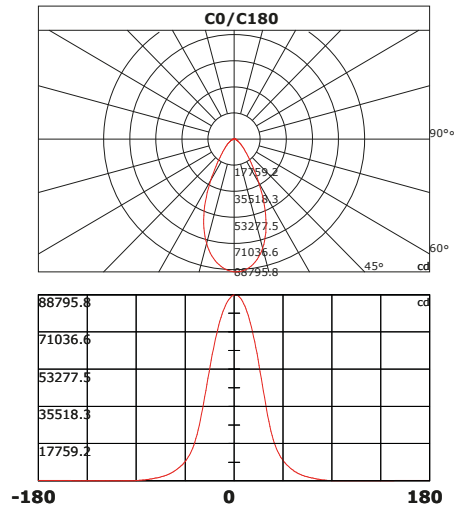

90° Lens

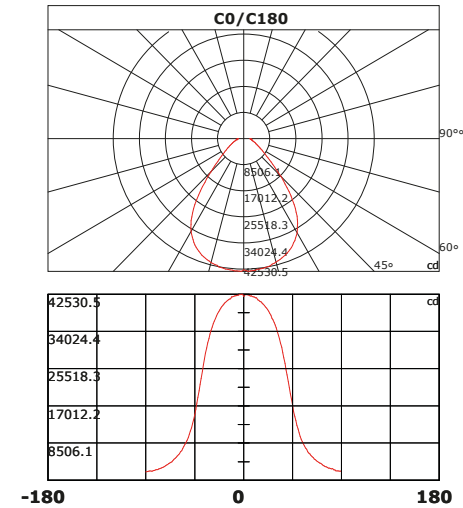

120° Lens

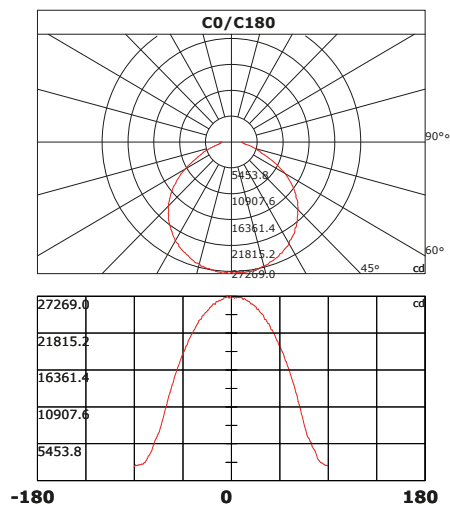

BEAM ANGLES

SENTRY FLOODLIGHT 1200W

