

DELTA LINEAR

BR-T60W

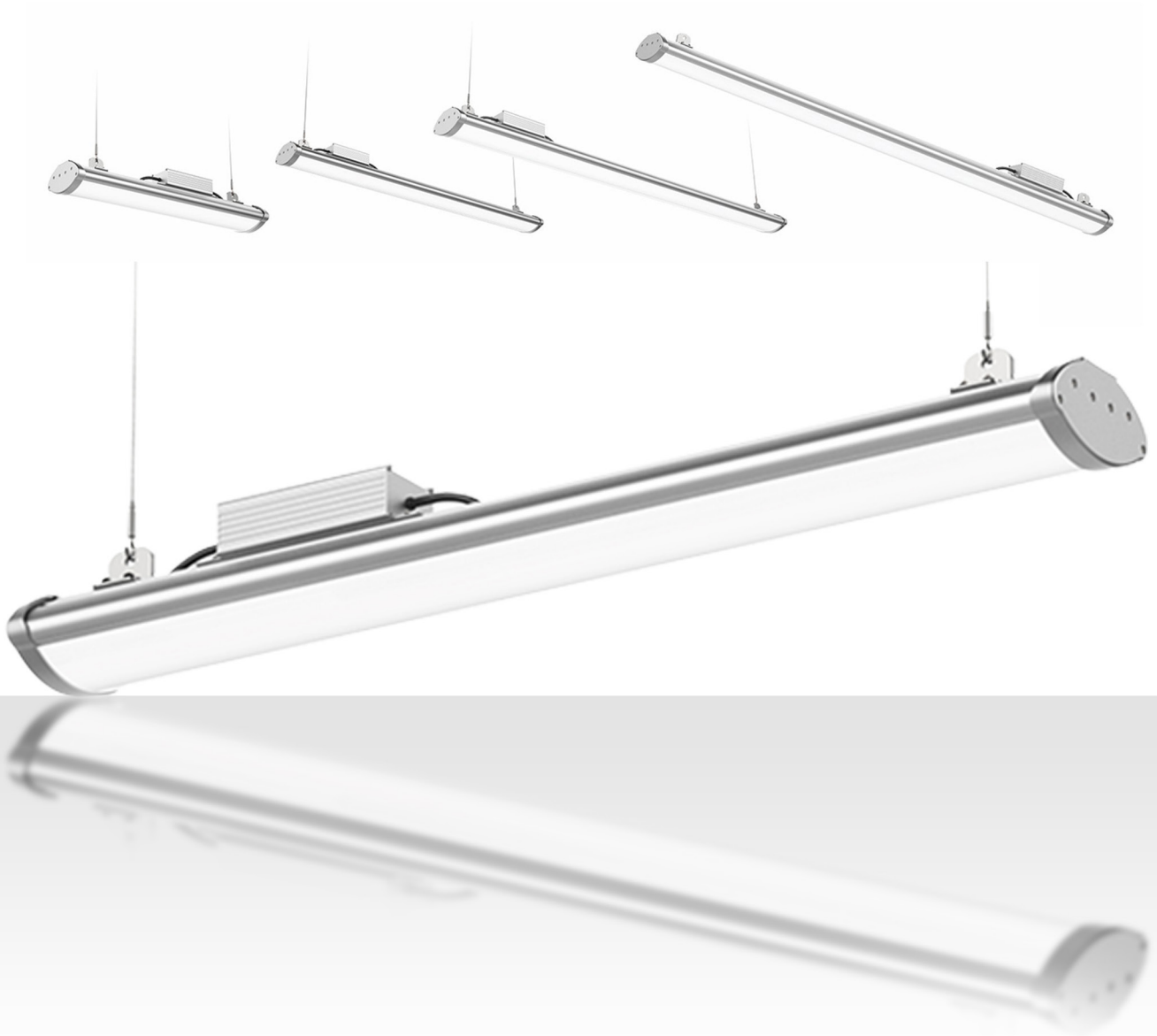

Brightman™
design efficiency



TECHNICAL DATA

DELTA LINEAR BR-T60W

Input Voltage	AC110-277V ~ 50/60 Hz
LED Chips	Philips EMC3030
Driver	TOMCARLINE
LED Quantity	84pcs
LED Power	60W
Led Luminous Efficiency	140lm/w
Luminous Flux	8,400lm
Power Factor	>0.90
Colour Temperature	3000K / 4000K / 5000K / 6500K
Colour Rendering Index	Ra≥70
Beam Angle	120°
Dimmable	Optional 1-10V / DALI
Working Temperature	-20°C ~ 69°C
Working Humidity	10%~ 90% RH
IP Rating	IP65
Net weight	3.7Kg
Life-span	>50,000hrs
Power Cable	1.0mm ² Triple shield wire
Connection Wire	Brown=Live, Blue=Neutral, Yellow=Earth
Housing Material	Aluminum & PC Cover
Housing Colour	Aluminium
Mounting Options	Chain or Surface



DIMENSIONS

DELTA LINEAR BR-T60W

