

# 900 SERIES

LED FLOODLIGHT

# 400W

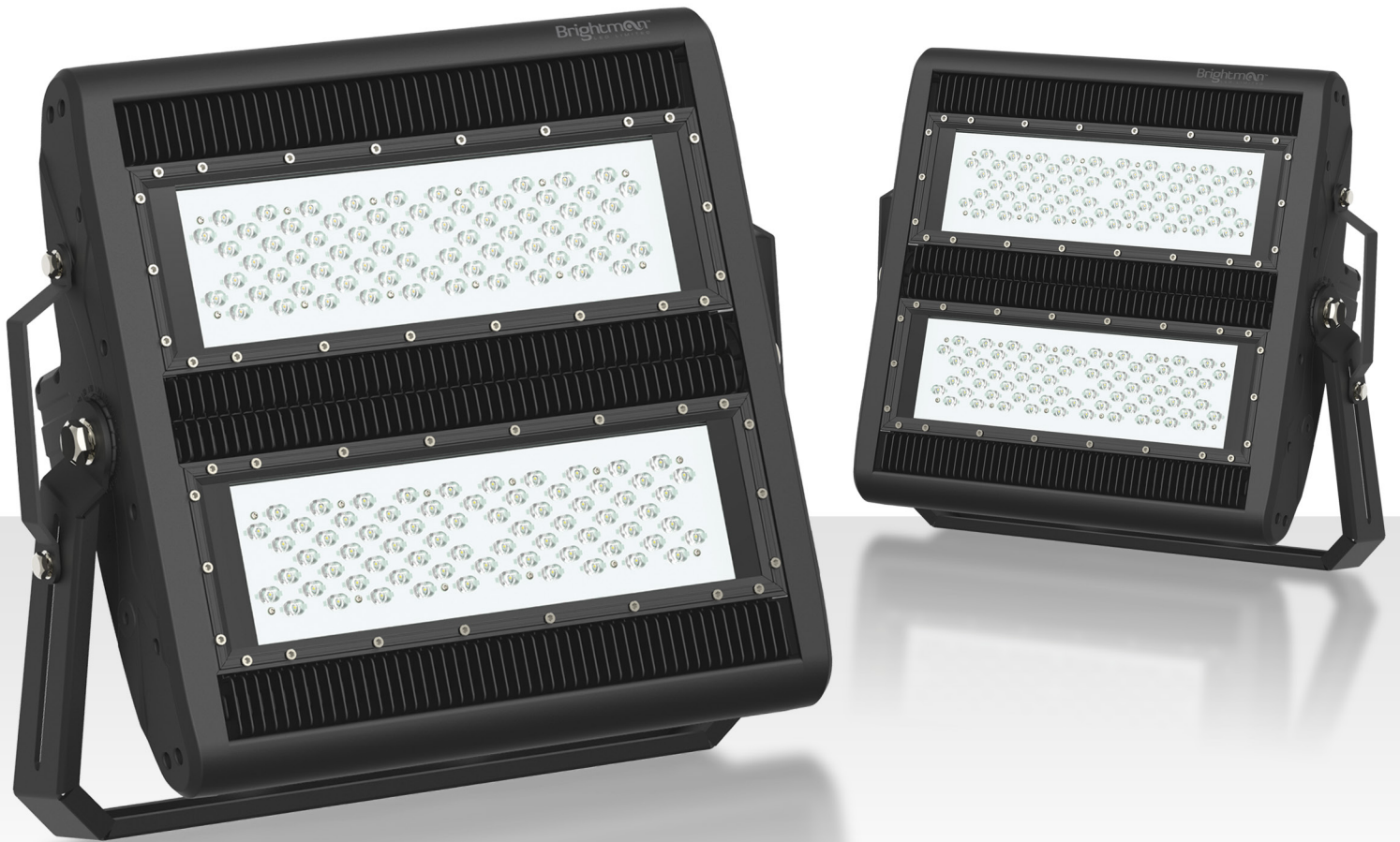

**Brightman**<sup>TM</sup>  
design efficiency



# TECHNICAL DATA

## 900 SERIES 400W LED FLOODLIGHT

Input Voltage	90-305 VAC, 50/60 Hz or DC
LED Chips	Philips Lumileds (Luxeon TX)
Driver	Mean Well
LED QTY	200pcs
LED Power	400W
Led Luminous Efficiency	140lm/W
Luminous Flux	56,000lm
Illuminance Uniformity	>0.8
Colour Temperature	3000-7000 K
Colour Rendering Index	Ra≥75
Beam Angle	60°x135°, 85°x45°, 85°x90°, 85°x135°
Illuminance Design	LED+lens
Working Temperature	-40 to +45 °C
Working Humidity	15%~ 90% RH
IP Rating	IP65
Net weight	19Kg
Life-span	>60,000hrs
Power Cable	1.0mm <sup>2</sup> Triple shield wire
Connection Wire	Brown=Live, Blue=Neutral, Yellow=Earth
Housing Material	Diecast Aluminium
Housing Colour	Black, Gray, White or custom
Available Options	<ul style="list-style-type: none"><li>• DALI Dimmer, Microwave or PIR Sensor</li><li>• SUS316 Stainless steel and Dacromet™ coating for marine application</li></ul>

The light parameters may differ between different color temperature, tolerances ≤ 5%.



# DIMENSIONS

900 SERIES 400W LED FLOODLIGHT

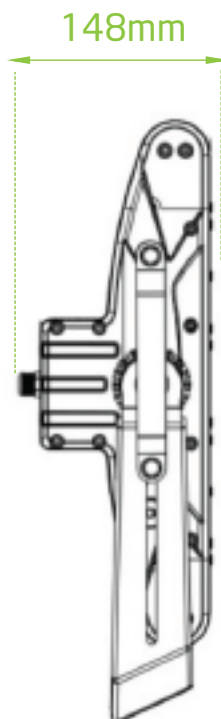
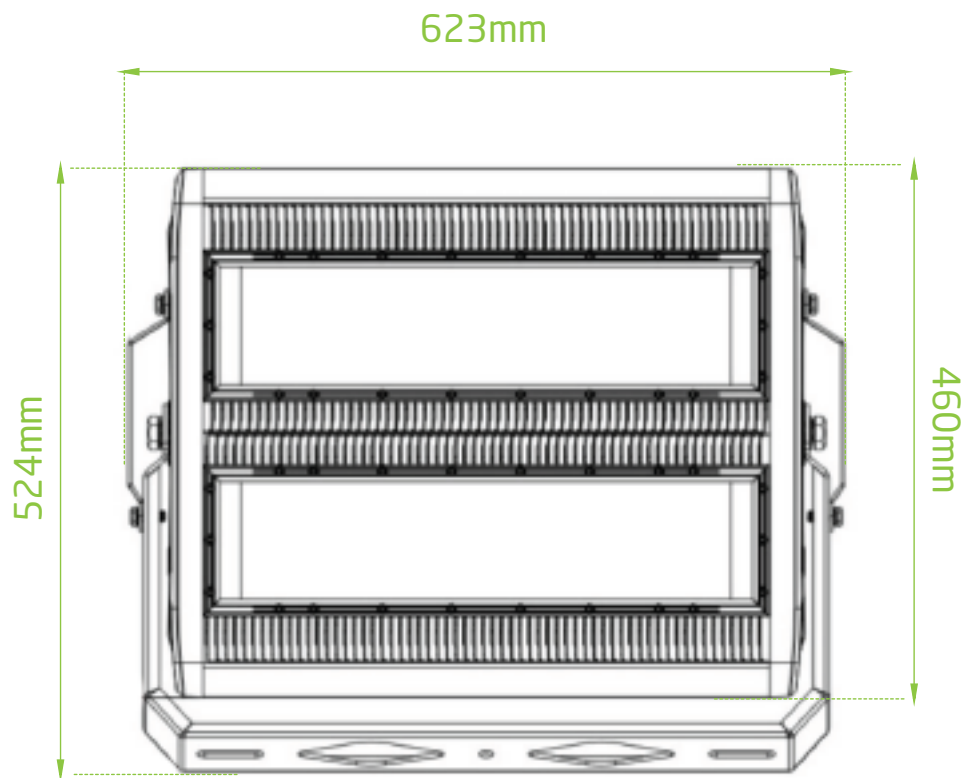

# PHOTOMETRIC DISTRIBUTION

900 SERIES 400W LED FLOODLIGHT

Beam Angle: 30° x 30°

M	LUX	ΦM
4	6996	2.1
6	3201	3.2
8	1814	4.2
10	1163	5.3

BEAM ANGLE=30x30 DEG

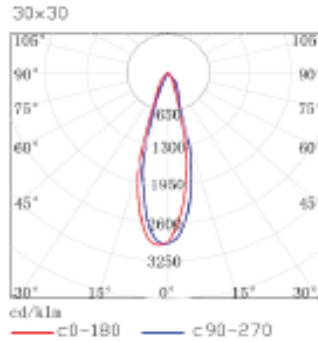

Beam Angle: 40° x 40°

M	LUX	ΦM
4	5541	2.9
6	2455	4.4
8	1376	5.8
10	878	7.3

BEAM ANGLE=40x40 DEG

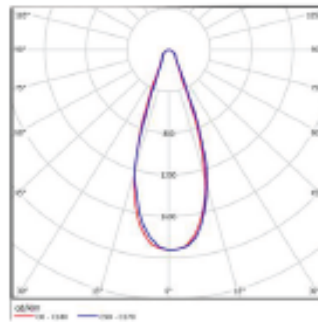

Beam Angle: 60° x 135°

M	LUX	W/L(M)
2	2714	2.3/9.6
4	699	4.6/19.3
6	312	6.9/28.9
8	176	9.2/38.6

BEAM ANGLE=60x135 DEG

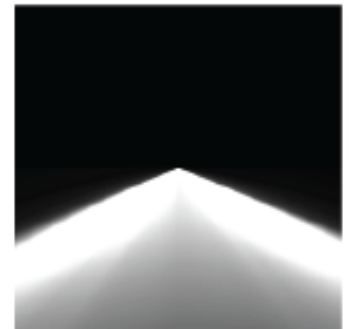
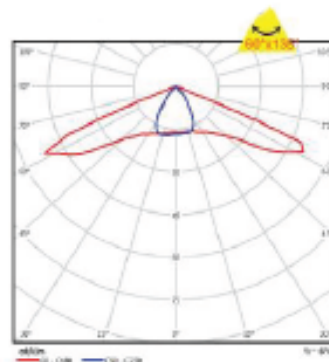

Beam Angle: 85° x 135°

M	LUX	W/L(M)
2	3249	3.6/ 9.6
4	799	7.3/ 19.3
6	357	10.9/ 28.9
8	199	14.6/ 38.6

BEAM ANGLE=85x135 DEG

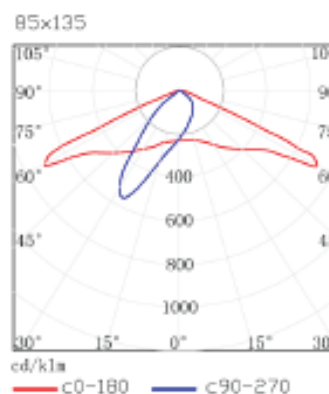

# THERMAL IMAGERY TEST

900 SERIES 400W LED FLOODLIGHT

### Front Projection

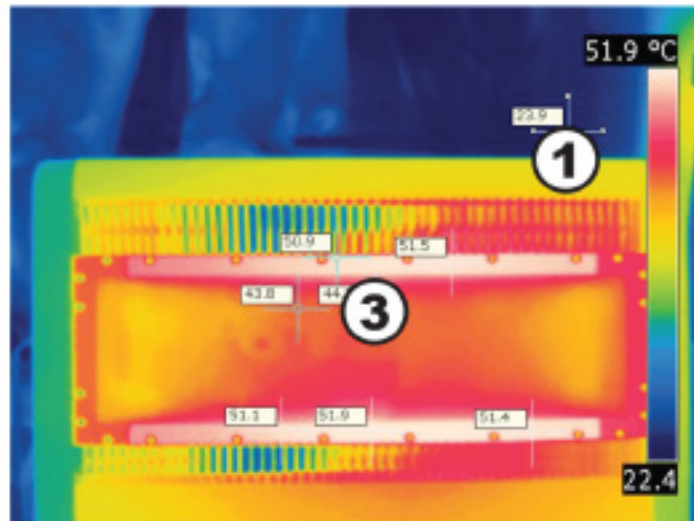

### Rear Projection

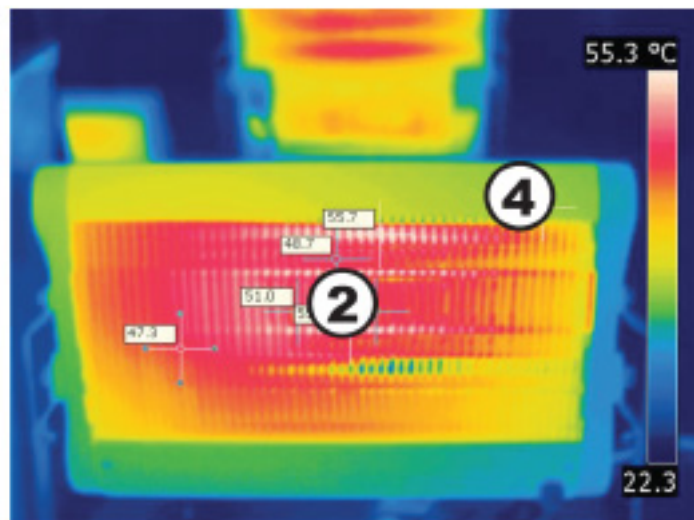

Number 1	23.9 °C	Edge
Number 2	47.8 °C	Fins
Number 3	44.3 °C	LED Chips
Number 4	32.2 °C	Driver Cover

# OPTIONAL WIRELESS SUPPORT 900 SERIES 400W LED FLOODLIGHT

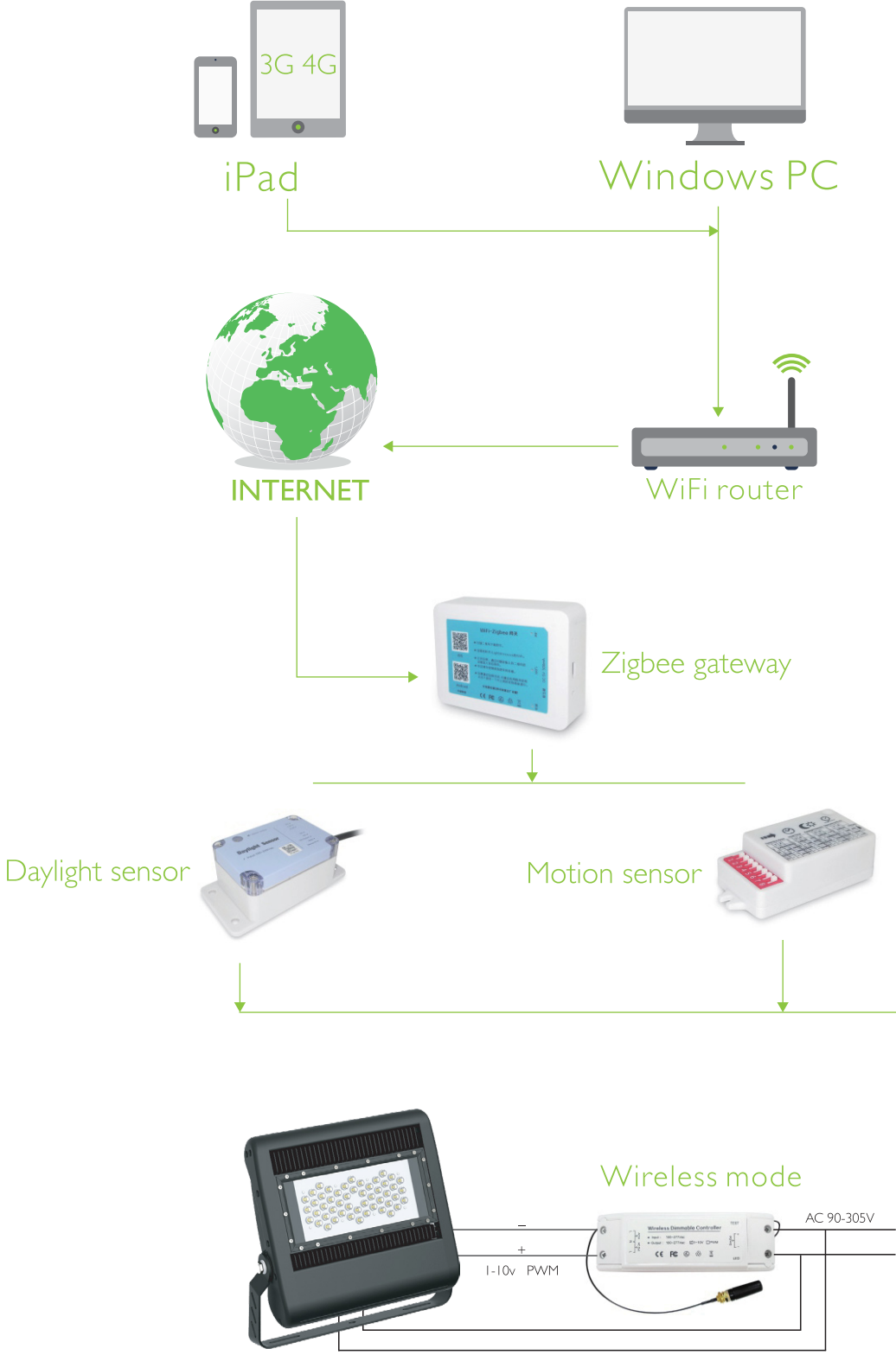

Dimmable Schematic Circuit Diagram